

ARCHETTO SPACE

LED SYSTEM

TYPE:

PROJECT NAME:

Archetto Space is the newest entry in the Antonangeli Archetto Collection, which has started in 2012 and since then has been including innovative products. They can be integrated and offer exclusive possibilities for light design and application by using the most recent LED technology. Archetto Space, an Antonangeli patent, thanks to the materials and the technology used in the Collection, allows the user to 'free the light in spaces by creating spaces of light'.

The luminous segments made of silicone, which are long 1 to 5 meters, are applied on tensile structures and freely run upon them.

Thus resulting in unusual, personalized and flexible 'floating' direct, indirect or 360° light effects.

Thanks to Archetto Space, the Archetto Collection enriches the range of possibilities for the designers. The new and original 'pencil of light' dematerializes the shape, which is free, lighter and movable: always to the benefit of a touching light.



SPECIFICATION SHEET

ARCHETTO SPACE

LED SYSTEM

TYPE:

PROJECT NAME:

Materials:
Silicone with graphene structure
Strip LED
Steel tensile structure

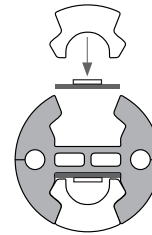

D 2,2 cm
(0.86")

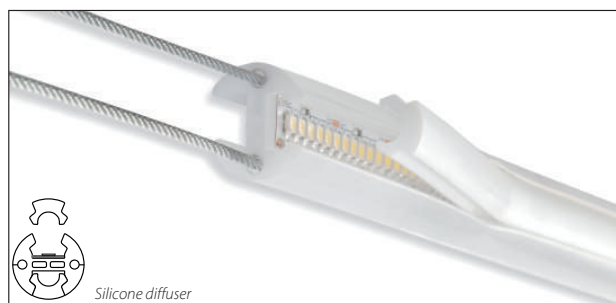
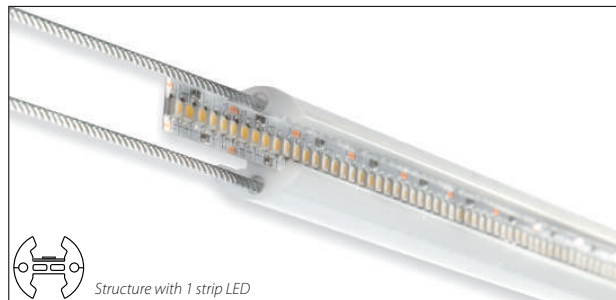
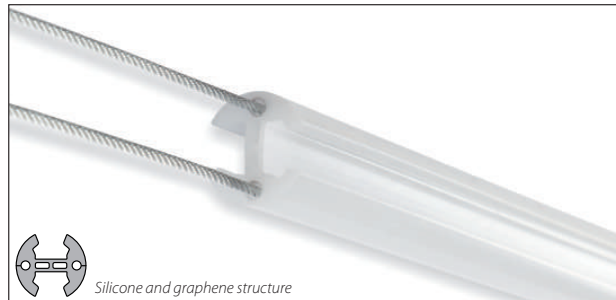

SPECIFICATION SHEET

ARCHETTO SPACE

LED SYSTEM

TYPE:

PROJECT NAME:

Archetto Space/1 strip LED

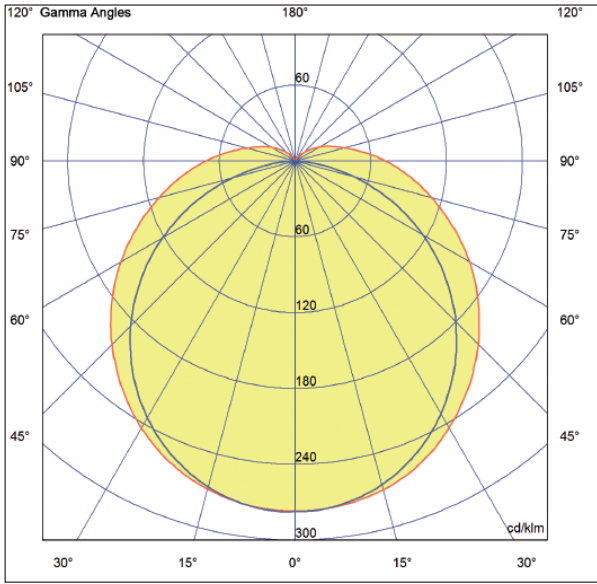

C semiplanes: 180°—0°/270°—90°
 Sample dimension: 100 cm x 2,2 cm
 Flow: 1108,77 lm
 Maximum: 277,82 Cd/Klm
 Position: C=330,00 G=3,00
 Performance: 100,00%
 Asymmetrical

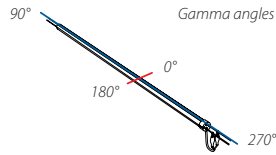

Archetto Space/2 strip LED

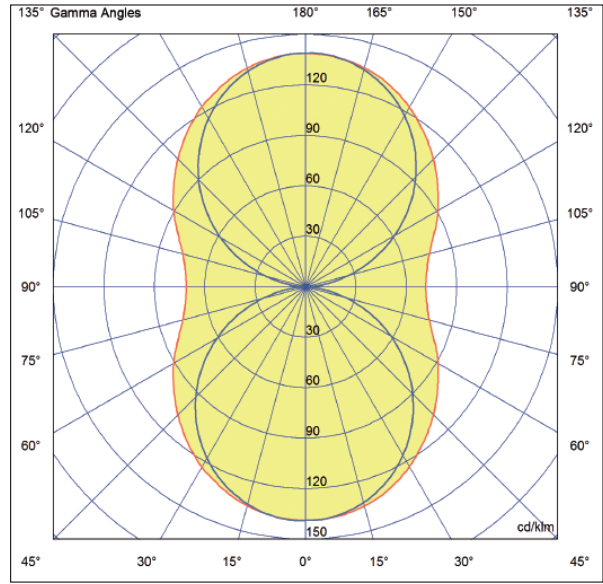

C semiplanes: 180°—0°/270°—90°
 Sample dimension: 100 cm x 2,2 cm
 Flow: 2217,56 lm
 Maximum: 139,23 Cd/Klm
 Position: C=30,00 G=177,00
 Performance: 100,00%
 Asymmetrical

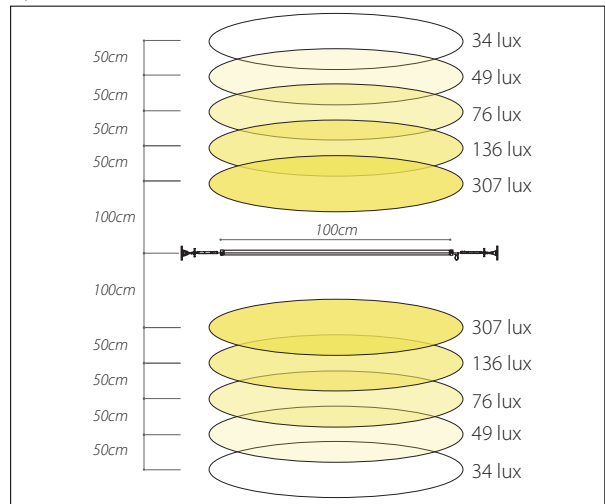
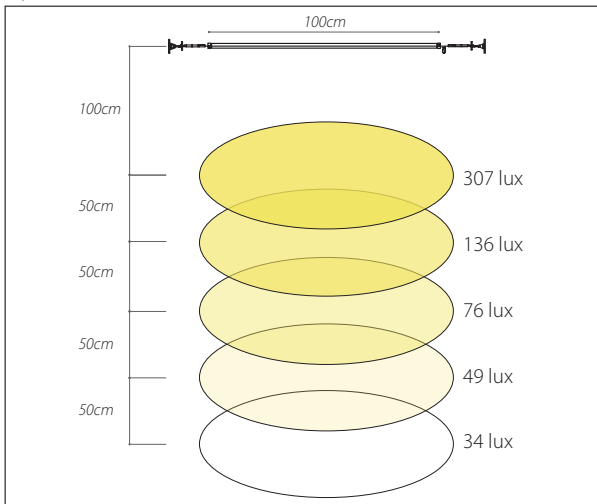
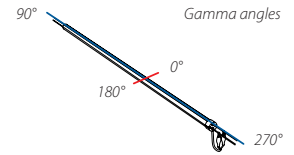

ARCHETTO SPACE

SPECIFICATION SHEET

ARCHETTO SPACE

LED SYSTEM

TYPE:

PROJECT NAME:

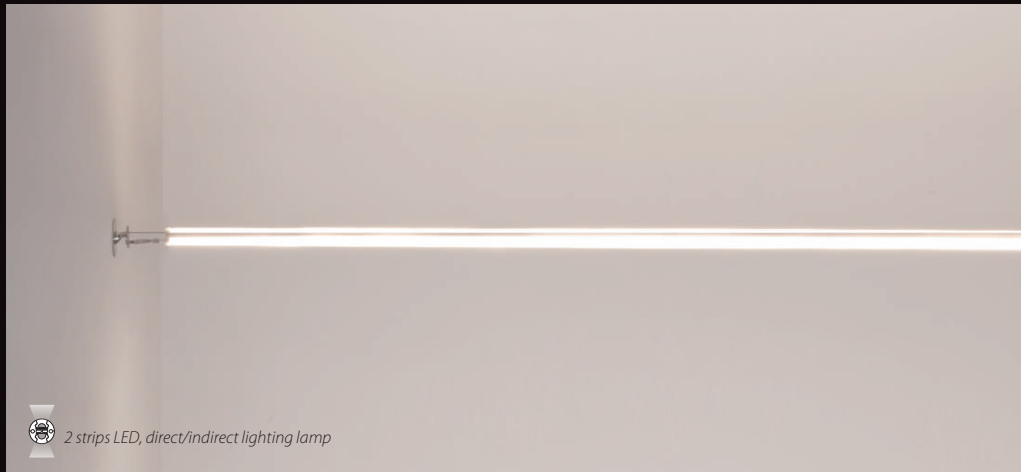
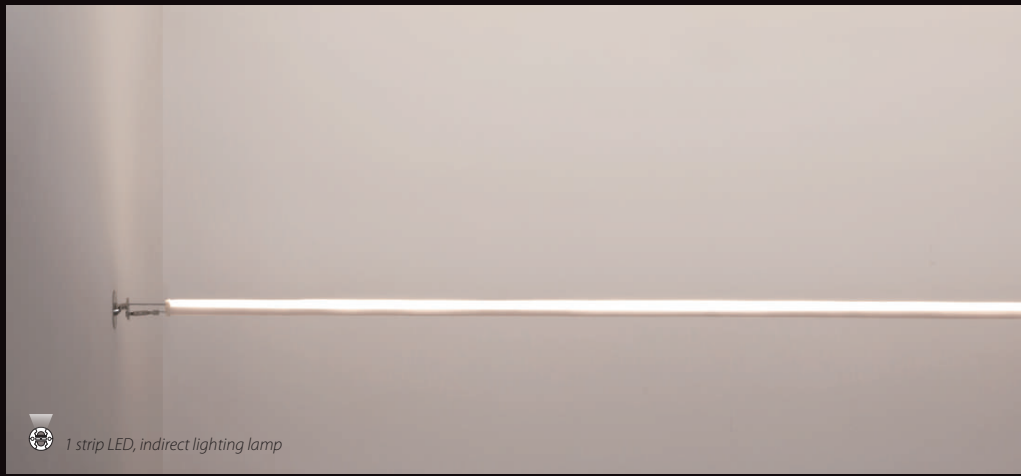

ARCHETTO SPACE

SPECIFICATION SHEET

ARCHETTO SPACE

LED SYSTEM

TYPE:

PROJECT NAME:



STRIPLED 3000°K / 4000°K **A+**
Each meter: 240 LED / 24V / 1.2W / 2200 lm

Single Emission
(Direct or Indirect)



1 meter (3' 3.7")

2700°K Cod. ARCSPL01M2 24V 12W 1110 lm
3000°K Cod. ARCSPL01M3 24V 12W 1110 lm
4000°K Cod. ARCSPL01M4 24V 12W 1110 lm

2 meters (6' 6.7")

2700°K Cod. ARCSPL02M2 24V 24W 2220 lm
3000°K Cod. ARCSPL02M3 24V 24W 2220 lm
4000°K Cod. ARCSPL02M4 24V 24W 2220 lm

3 meters (9' 10.1")

2700°K Cod. ARCSPL03M2 24V 36W 3330 lm
3000°K Cod. ARCSPL03M3 24V 36W 3330 lm
4000°K Cod. ARCSPL03M4 24V 36W 3330 lm

4 meters (13' 1.4")

2700°K Cod. ARCSPL04M2 24V 48W 4440 lm
3000°K Cod. ARCSPL04M3 24V 48W 4440 lm
4000°K Cod. ARCSPL04M4 24V 48W 4440 lm

5 meters (16' 4.8")

2700°K Cod. ARCSPL05M2 24V 60W 5550 lm
3000°K Cod. ARCSPL05M3 24V 60W 5550 lm
4000°K Cod. ARCSPL05M4 24V 60W 5550 lm

Double Emission
(Direct+Indirect)



1 meter (3' 3.7")

2700°K Cod. ARCSPL01B2 24V 24W 2220 lm
3000°K Cod. ARCSPL01B3 24V 24W 2220 lm
4000°K Cod. ARCSPL01B4 24V 24W 2220 lm

2 meters (6' 6.7")

2700°K Cod. ARCSPL02B2 24V 48W 4440 lm
3000°K Cod. ARCSPL02B3 24V 48W 4440 lm
4000°K Cod. ARCSPL02B4 24V 48W 4440 lm

3 meter (9' 10.1")

2700°K Cod. ARCSPL03B2 24V 72W 6660 lm
3000°K Cod. ARCSPL03B3 24V 72W 6660 lm
4000°K Cod. ARCSPL03B4 24V 72W 6660 lm

4 meters (13' 1.4")

2700°K Cod. ARCSPL04B2 24V 96W 8880 lm
3000°K Cod. ARCSPL04B3 24V 96W 8880 lm
4000°K Cod. ARCSPL04B4 24V 96W 8880 lm

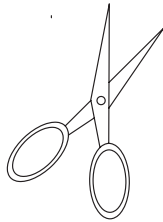
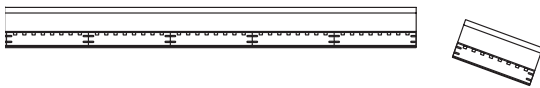

It's possible to cut
ARCHETTO SPACE® every 2.5 cm

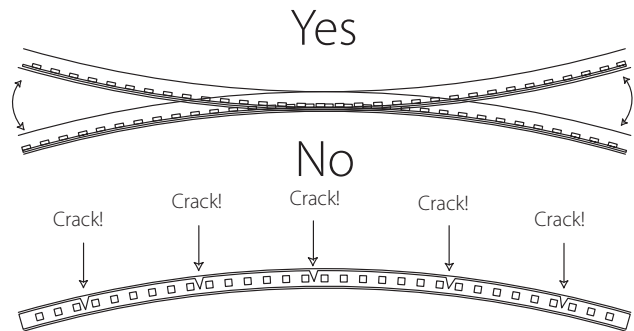

ARCHETTO SPACE

LED SYSTEM

TYPE:

PROJECT NAME:

TENSILE STRUCTURE COMPONENTS

Wall/Ceiling applications stainless steel tie kit

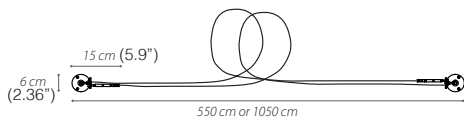

Cod. ARCSPT01 L. 550 cm
Cod. ARCSPT02 L. 1050 cm

Floor/Ceiling vertical applications kit with 'Serena' stone base

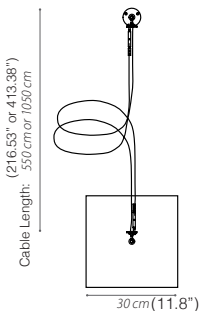

Cod. ARCSPF01 L. 550 cm (216.53")
Cod. ARCSPF02 L. 1050 cm (413.38")

Tie rod kit with small spacer brackets for wall / ceiling applications in chromed metal

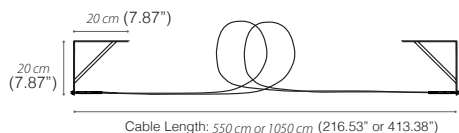

Cod. ARCSPW01A L. 550 cm (216.53")
Cod. ARCSPW01B L. 1050 cm (413.38")

Tie rod kit with large spacer brackets for wall / ceiling applications in chromed metal

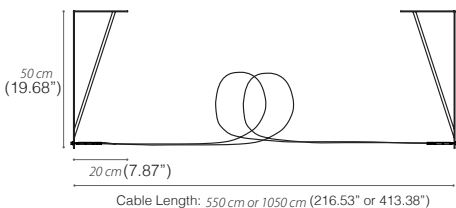

Cod. ARCSPW02A L. 550 cm (216.53")
Cod. ARCSPW02B L. 1050 cm (413.38")

Chromed metal ceiling cables holder



Cod. ARCSPK01A

Chromed metal wall cables holder

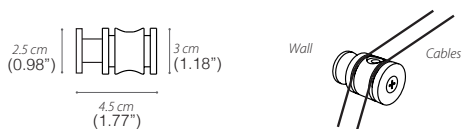

Cod. ARCSPK01D

SPECIFICATION SHEET

ARCHETTO SPACE

LED SYSTEM

TYPE:

PROJECT NAME:

Chromed metal ceiling cables long holder

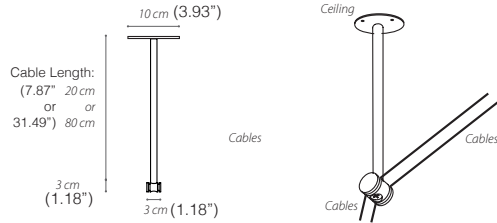

Cod. ARCSPK01B L. 20 cm (7.87")
Cod. ARCSPK01C L. 80 cm (31.49")

Horizontal line diverter on the wall

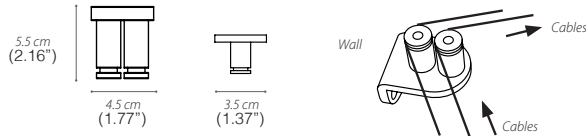

Cod. ARCSPK01E

Horizontal line diverter on the ceiling

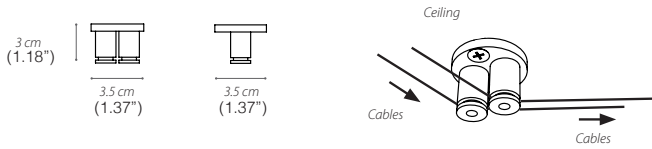

Cod. ARCSPK01F

Steel sustaining line holder cable



Cod. ARCSPK02

For very long horizontal composition we suggest to use this lamp holder in transparent plexiglass to keep the lamp straight.

Remote power feed canopy



Cod. ARCSPK03

Easy mounting light segment tool



Cod. ARCSPK04

To ease the lamp mounting, we developed this tool that makes the installation faster and more comfortable.

Item included in every shipment

ARCHETTO SPACE

LED SYSTEM

TYPE:

PROJECT NAME:

TENSILE STRUCTURE POWER SUPPLIES

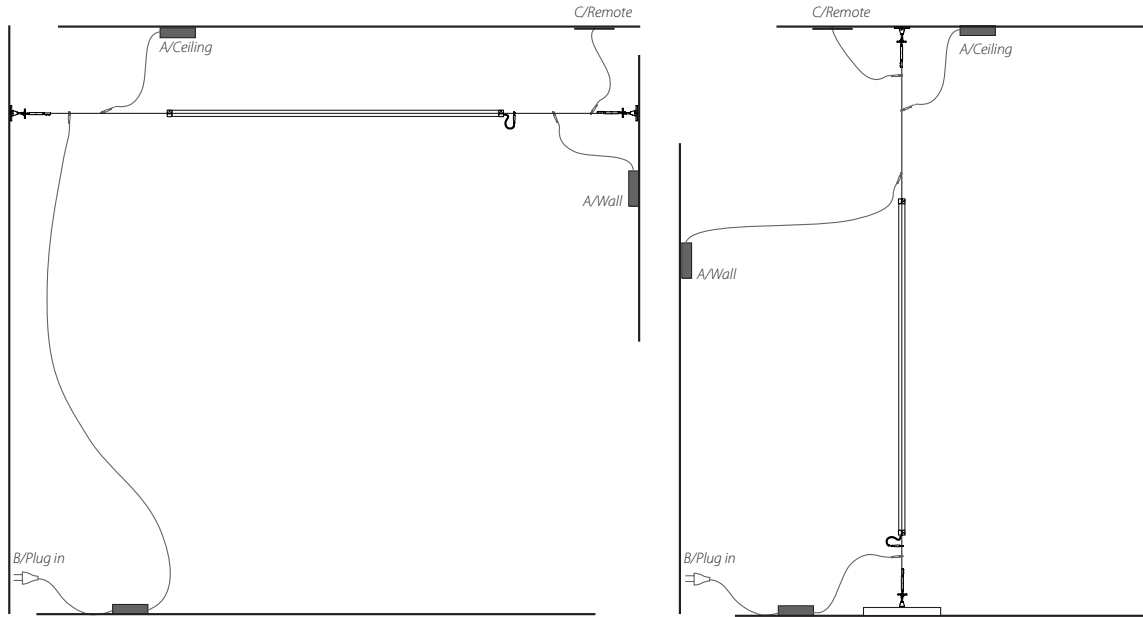

TENSILE STRUCTURE POWER SUPPLIES

A / Ceiling/wall power supplies with matte white case

75W Cod. ARCSPDW01 Dim. 38x8x6cm 24V
 96W Cod. ARCSPDW02 Dim. 38x8x6cm 24V



B / Plug-in power supplies with matte white case

75W Cod. ARCSPDF01 Dim. 32x15x6cm 24V
 96W Cod. ARCSPDF02 Dim. 32x15x6cm 24V



C / Remote power supplies with plate

75W Cod. ARCSPDR01 Dim. 16x10x4cm 24V
 96W Cod. ARCSPDR02 Dim. 20x10x5cm 24V



SPECIFICATION SHEET

ORDERING INFO

Model (Order Code)

Voltage

Dimming

Please note:

277V is only compatible with 0-10V dimming

120V

LTE (Leading/Trailing Edge Dim)

277V

010V (0-10V)



Installation note: Comes with a 4" backplate that mounts to a standard junction box

ARCHETTO SPACE

LED SYSTEM

TYPE:

PROJECT NAME:

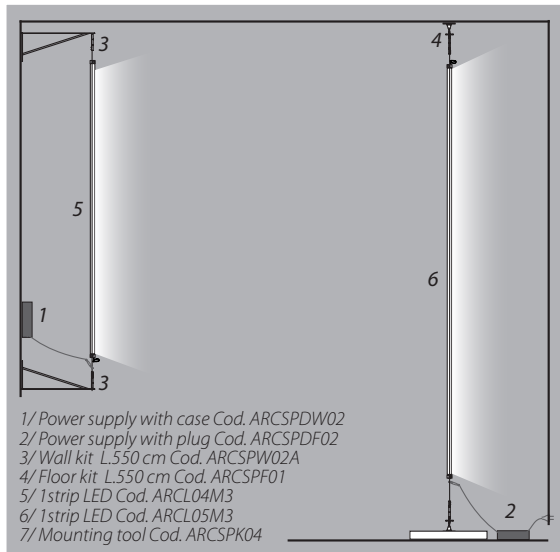
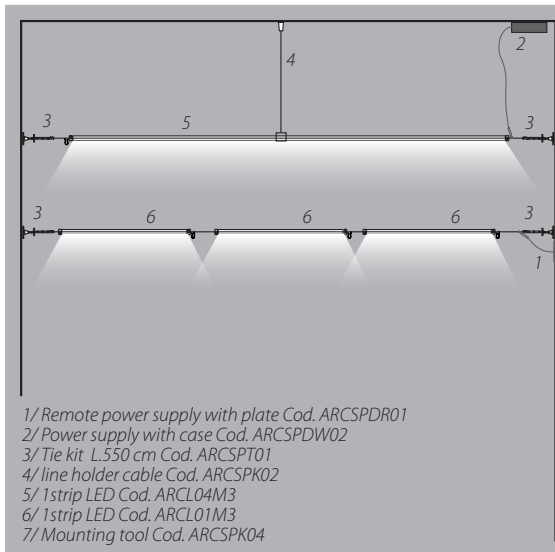
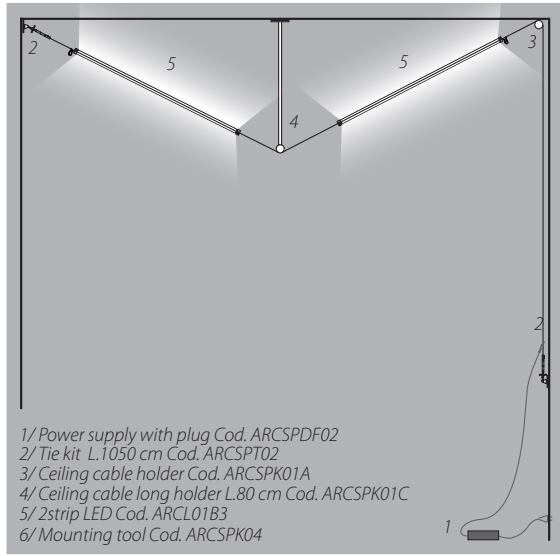
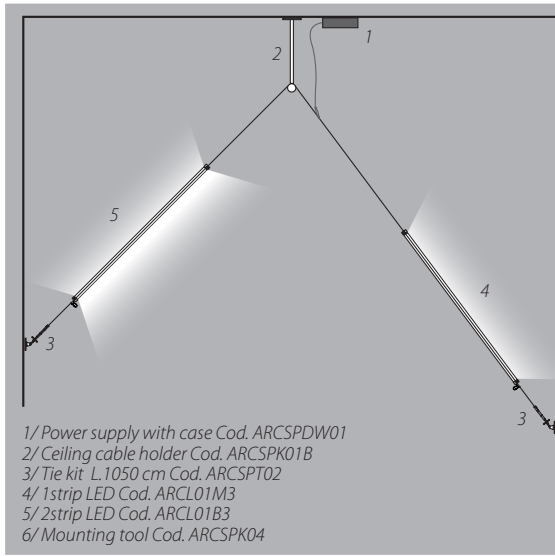
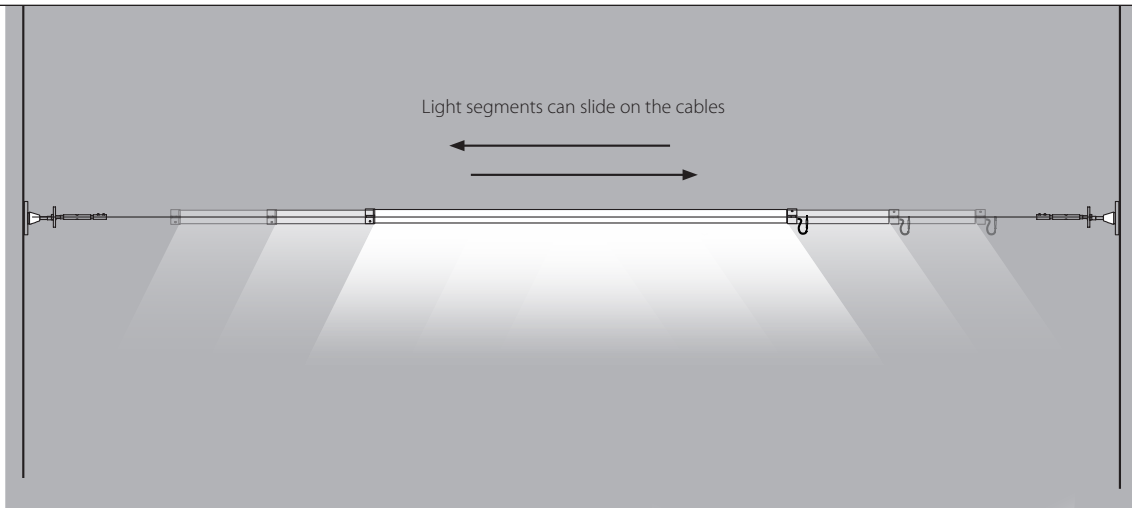

SPECIFICATION SHEET